

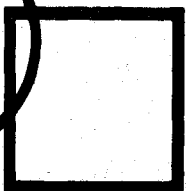

"PROMENADER"



VOL. XXI NO. 1 ROCHESTER, NEW YORK NOVEMBER, 1982

*Happy
Thanksgiving
1982*

ROCHESTER AREA FEDERATION OF WESTERN ROUND AND SQUARE DANCE CLUBS INC.

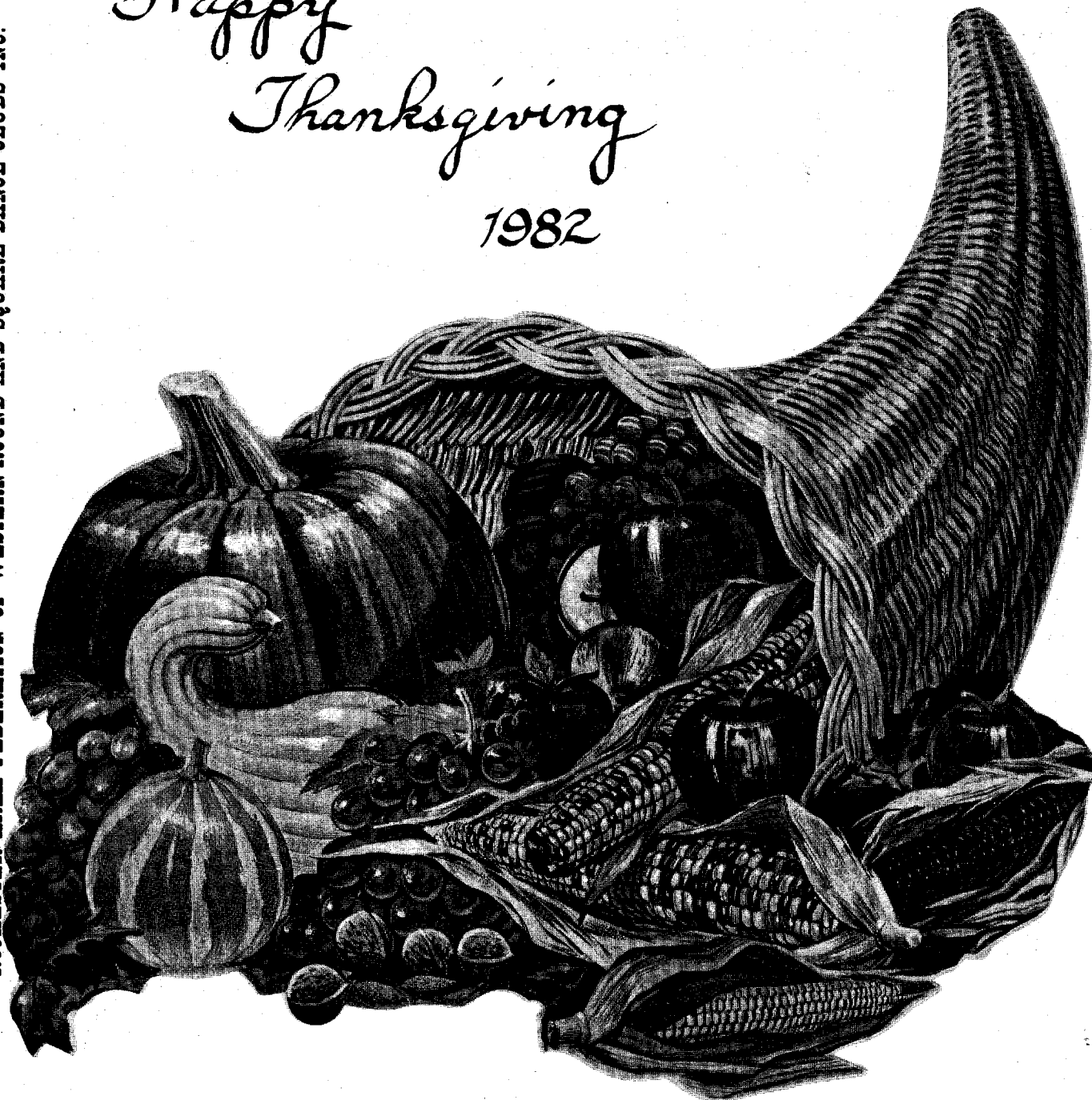



Editor's Note:

It's time once again to stop and reflect on the many blessings that have been bestowed upon us during the past year and to give thanks for them.

I, personally, am thankful for you, the many square dancing friends that I have become close to in the past nearly two years. You have given me support and helped me through several trying periods in my personal life. Sometimes, I don't think I could have made it without you. Thank you again and again for all that you have done. Rochester has become my home and I'd rather be here than anywhere.

The Cure (Leukemia) Dance will be held this year at the Churchville-Chili Senior High School (same as last year) on June 3rd, 1983. I realize that it seems a long way off for most of you but a lot of careful planning must go into it to make it a success and we are at the beginning of that planning now. If anyone would like to work to help find a cure for childhood cancer by serving on or chairing a committee, PLEASE contact me at home any time (716-768-2949). Every little bit helps towards that goal of finding a cure.

Have a happy holiday.

Your Editor,
Arlene



HAPPY THANKSGIVING
FROM
THE PROMENADER STAFF

Nick & Arlene Caputo
Angie & Alice DeFelicce
John & Taphne Fink

PROMENADER is published by the Rochester Area Federation of Western Round and Square Dance Clubs, Inc. Editors reserve the right to edit, omit, or delete material submitted for publication.

Subscriptions: \$5 per year for 9 issues: November, Dec/Jan, Feb., March, April, May, Summer, Sept., October. Checks for ads or subscriptions, payable to PROMENADER. Deadline for ads and copy: First of the month preceding publication.

Editors

Nick & Arlene Caputo
P. O. Box 2
LeRoy, New York 14482
716-768-2949

Subscription Editors

Angie & Alice DeFelicce
80 Wolcott Street
LeRoy, New York 14482
716-768-8674

AD INFORMATION	and	SIZE OF COPY TO SUBMIT
\$35 Full page		8 1/2 inches wide by 11 inches high
22 Half page		9 3/4 " " by 6 1/2 " "
16 Quarter page		4 3/4 " " by 6 1/2 " "
8 Eighth "		4 3/4 " " by 3 1/4 " "

Additional charge for reductions: \$3.25
makeup of ad 7.00

Paid Reader Ads are accepted at the rate of \$2 for 20 words, plus 5¢ each additional word.

Note: All ads or photos must be black on white. Do not use colored paper, colored inks, or Xerox copies.

FEDERATION OFFICERS

PRESIDENT

Ed & Ginny Penczek
333 Fishers Road
Pittsford, New York 14534
924-2743

VICE-PRESIDENT

Bob Dailey
428 Johnson Road
Bergen, New York 14416
494-2102

TREASURER

Ed & Janet Leurgans
25 Mill Valley Road
Pittsford, New York 14534
248-2763

RECORDING SECRETARY

Orlo & Rita Hoadley
18 Kingsberry Drive
Rochester, New York 14626
225-2796

CORRESPONDING SECRETARY

Nancy Donald
161 Lake Breeze Park
Rochester, New York 14622
338-1080

NEXT MEETING: Thursday, November 18th at 8 p.m.
Unitarian Universalist Church,
S. Clinton Avenue at Court Street

Calendar of Coming Special Events

The purpose of this Special Events Calendar is to aid clubs in planning their activities and to avoid the conflict of big events on the same date. We can't provide this data if we are unaware of your future dances ahead of time. Please take this into account and let the Editor know when you schedule a big event as soon as you know the dates. Thanx.

November 6th	Orleans Orbits	Apple Fest
November 8th	Geneva Friendship Squares	Marshall Flippo
November 12th	Web Spinners	Norm Wilcox
November 19th	Promenading B's	Turkey Dance
November 19th	Lima Grand Squares	Harvest Dance
December 4th	Country Twirlers	Gloria Roth
December 11th	Kuntry Kuzzins	Jim Lee-Canada
December 18th	Irondequoit Squares	Poinsettia Prom
January 21st	Web Spinners	Beginner's Ball
January 28th	Web Spinners	Jerry Carmen
January 29th	Glass Slippers	C/W Celebrity Nite
February 4	Newcomer's Caper	Carmen/Kellogg
February 5th	Irondequoit Squares	Valentine Dance
February 12th	Henrietta Friendship Squares	President's Ball
March 20th	" "	Bud Redmond
March 25th	Web Spinners	Mike Callahan
March 26th	Promenading B's	Black Light Dance
April 10th	Geneva Friendship Squares	Dick Bayer
April 14th	Genesee Dancers	Ed Foote
April 15th	Batavia (Advanced)	Ed Foote
May 7th	DANCE-O-RAMA	
May 10th	Triggers	Spring Fling
May 22nd	Geneva Friendship Squares	Dick Leger
June 3rd	C.U.R.E. Dance	
June 23, 24, 25	NATIONAL CONVENTION	Louisville, Ky.



CARMEN'S COLUMN



When I first began square dancing, one of the things that distinguished eastern from western square dancing was mixing. At eastern style dances, it was not uncommon to come with your own square and only dance with them the entire evening. At the western dance, there were no set squares and everyone danced with different people each tip. The mixer dance, usually done in a large circle, was a regular part of the evening and everyone joined in. As progress set in and western style square dancing grew, so did little groups of people who would only dance with each other. Why, at some clubs you could dance for years and never get to dance with certain people!

Some callers and far-sighted dancers, realizing this was not good for club growth and spirit, devised different ways of encouraging people to mix (as couples) during the evening. By far, the most successful method to evolve has been the NUMBER SYSTEM.

There are different number systems, but the concept of them all is to assign each couple a number and set up squares by grouping four number together, preferably in a random fashion. The groupings are changed every tip. The location of each square on the floor is determined by the caller. Square #1 might be the front square to the caller's left, square #2 in the middle front, etc. So, each tip during the evening you would be assigned a different position on the floor with a different group. This also means you don't have to worry about sitting out because you weren't fast enough to get into a square, you won't insult your friends by not dancing with them all evening and all the beginners won't group together in the back of the hall. There are usually not enough to make even squares, but all will have an equal opportunity to dance and to sit one out. Those who wish to sit one out can always exchange with a couple for that tip. Persons whose partner cannot dance can sign in as a couple and dance with the partner of someone who is sitting out. Usually the first and last tip of the evening are open for everyone to square up as they wish. If you come with friends you can reserve this time for them.

Callers like this because it "evens out the floor", and provides for a more congenial group. Disadvantages are, it's cumbersome with large groups and difficult to compensate for a significant number of early leavers. Complaints have been, "too mechanical" and "can't dance with my friends".

Currently, the number system is popular only with advanced/challenge groups where it has effectively served to mix dancers of different experience and ability and provide a better evening for all.

Jerry Carmer

CCR News



Our meeting on October 3rd presented our new format, a streamlined business meeting, followed by a participation session on choreography.

Zeroes and equivalents were the subjects of discussion with Chuck Prister working Basics and Chip Keillogg presenting the Plus movements. Both sessions were well prepared and very informative. These discussions were followed by two excellent live dance demonstrations. Myron Huss showed us the versatility of the calls Cross Trail and Cross Trail Thru and Ken Boss gave us a hundred or so ways to do a Trade By.



Oktoberfest! Did you go? Ve vent. Und it vas "Wonder Bar". Mit all dat drinking und singing my accent came back. The vun I got ven me und my Frau vent on a trip to Europe.

You would never guess vot country. You're right, Chermany! Somebody must haf told you. Ya, da Fatterland. Und now I know vhy dey call it da Fatterland, because uf da delicious food everybody iss getting fatter und fatter.

Ve tried so hard to speak und understand da language dat I started to speak mit an accent. Alldough you can hardly notice it. Dey said don't drink da vater. I didn't. I drank da beer und I almost get a hernia trying to lift da heavy steins.

Driving on da Autobahn to Berlin vas very exciting und confusining. Da confusion came from da signs along da road, "Aus Fahrt", "Ein Fahrt", und "Gut Fahrt". From dis you wouldn't know vich vay to Fahrt! Soooo, vonce you learn dat Aus Fahrt vas Exit und Ein Fahrt vas Entrance, und Gut Fahrt vas Good Chourney, den it is easy to know vich vay to go....

Und now ve vent to Munich the home of da Oktoberbest. In a large Beer Garten dey had a Cherman band vich vent "Ump pa pa" and der vas many people round dancing. Dere vas no cueing, but about every fife minutes the leader of da band vould shout "Hler Prosit" und everybody vould go back to dere tables, lift up large steins of beer und shout "Prosit". I suppose that meant stop the dance.

The only square dancing vas a NATO Army Post in Mannheim. Da caller vas supposed to be calling in English but some of the calls sounded like Cherman. To me dis vas not unusual because even in Rochester some calls sound like Cherman to me.

Soooo ve choined a set und started dancing, und choost like here ve got all mixed up. The caller vas very nice about it. He stopped und valked us thru. Ve started dancing again und again our set got mixed up. Dis iss vere the caller paid me a compliment. He said in Cherman "Dumkopf", vich probably means Gut Dancer or something like that. Und ven he repeated "Dumkopf" da second time da entire set laughed und cheered. All callers should be dis friendly.

Vell, I tink dis is enough for now because dis accent iss hard on my voice (and my typewriter correction tape, Editor.) I tink I vill eat some saurkraut und soothe my throat.

Danke, anyway,
Hal Abberger

C.C.R. News, continued.

Between the business end of the meeting and the dancing part we had time to check on the latest singing calls. Bill and Judy Wilcox brough a few hundred of the newer releases for us to review and check out for key range and versatility. This is a very welcome new feature.

We wish to welcome caller, Dick Casper, to our group. vick's 13 years of experience are a great asset to C.C.R. and we all look for3ard to sharing some good times with him. Nice to have you, Dick!!

Dues are payable by the next meeting on November 7th if you wish to have your name included on the C.C.R. list that will be published in December.

Also we will be voting on changes in the by-laws at this meeting so, PLEASE, be there. After all, it's your club, Caller.

We'll see you on November 7th at 2:00 p.m., United Covenant Methodist Church, corner of Culver and Parsells. Information See you there,
288-1287 Mike & Mary Jane Herne

Round Dance News

The Round Dance Leaders of the Rochester Area Round and Western Square Dance Clubs meet once a month to choose the Round of the Month. This is for the benefit of the dancers so that they can go from club to club and enjoy Round Dancing as well as Square Dancing.

We met this month and chose the following rounds for the month of November:

Happy Go Lucky Morning TNT - 190
Louisiana Saturday Night Capitol 4983
also classic

Hot Lips Decca - 29558

Next meeting November 6th, 1982 at Mike & Linda

Libertis.

Information
352-5564

Betty & Bert Wolcott
Round Dance Leaders Chairmen

ROCHESTER AREA ROUND DANCE CUERS

Gordie & Sylvia Copeland	247-3383
Bob & Nora Slomcenski	342-6985
Betty & Jerry Carmen	352-5564
Howie & Dot DeGrave	594-5918
Rich LaQuay	454-4717
Mike Harris	288-7870
Bernie & Rita Hayward	538-4954
Dottie Reed	(315) 331-1719
Brian & Judy Adams	682-3150
Betty & Bert Wolcott	343-8022
Mike & MaryJane Herne	288-1287
Mike & Linda Liberti	227-6573
Jody Mattice	425-1751



Take

THE NEXT STEP

with
Bob & Nora Slomcenski

A special ROUND DANCE class for those who have already taken BASICS.

This class is designed to:

- Review the more involved BASIC steps (Fishtail, Whisk, etc.).
- Build from BASIC to INTERMEDIATE level rounds.
- Expand your knowledge of rounds to include:
 - Intermediate Waltz
 - Foxtrot
 - Cha-Cha
 - Rhumba
 - Tango



Sunday Evenings 7:30 - 10:00 PM
Starting: Sunday, Oct. 31st, 1982

East Rochester Presbyterian Church
109 East Avenue
East Rochester, New York

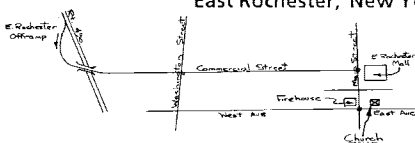

For information
call: 342-6985

PAID READER ADS

JERRY'S GEMS - Challenging PLUS LEVEL dancing. Jerry Carmen calling, Saturday, 8 - 10:30 p.m. November 13th, South Presbyterian Church, Corner Rtes. 15 and 15A.

JERRY'S FUNSHOP Advanced - 1 Level dancing, workshopping Advanced - 2 calls, Jerry Carmen calling, Sundays, 7:30-10:00 p.m. Chili Community Center, Buffalo Rd., near Rte. 259, West Chili, November 7th, 21st and 28th.

Dried Flower and/or Driftwood Arrangements; your container or mine. Unusual perennials. Call 436-8684. Audrey Mura.

SHAMROCK SQUARES A 1 LEVEL + Experimentals

Mondays: November 1, 8, 15, 22 & 29
Summerville Presbyterian Church, 4845 St. Paul Blvd. (near Lakeshore Blvd.) 8 p.m. Advanced Dancers Only. Mike Callahan (392-3807)

SHAMROCK SQUARES A 2 LEVEL + Experimentals

Tuesdays: November 2, 9, 16, 23 & 30
Covenant United Methodist Church, 1124 Culver Rd. (near Parsells Ave.) 8 p.m. Advanced Dancers Only. Mike Callahan (392-3807)

THE PARTY'S ALL SET! Former Twirl A Rounds and all Round Dancers, help us celebrate our club's twentieth anniversary on Saturday, November 13th at Wesley United Methodist Church, 2007 Dewey Ave. 7:30 'til midnight. Refreshments, Door Prizes. FREE!! Information 594-9518

ROUNDS, Easy Level. Tuesdays, 8 til 10:30, Churchville-Chili High School Cafeteria. 5786 Buffalo Road. Information 594-9518

INTERMEDIATE ROUNDS (Twirl A Rounds) Wednesdays, 7:30 til 10:30 p.m. Fairbanks Rd., Elementary School, N. Chili. Information 594-9518

FOR SALE 1968 Fan Trailer, 19 ft. Sleeps six adults, Self contained, refrigerator, stove, oven, furnace. Excellent condition. Asking \$1,500.00. Call after 5:30. (716) 526-5282

R.F. SQUARES - Ron Fotch calling the Plus Program for fun in the squares. 1st and 3rd Tuesdays of each month. November 2nd and November 16th. United Methodist Church, corner of Westside Drive and Buffalo Rd., N. Chili, 7:30 to 10 p.m. Rounds, too.

WE ARE GOING TO THE NATIONAL SQUARE DANCE CONVENTION!!!

Wanda & I have confirmed a bus from Trailways. We have room for 46 people. We will leave on Wednesday, June 22nd, 1983 and return on Sunday, June 26th, 1983. The Convention will be in Louisville, Kentucky. Make your plans now and watch for our flyers. We'd love to have you join us!!! Mike Callahan - 392-3807.

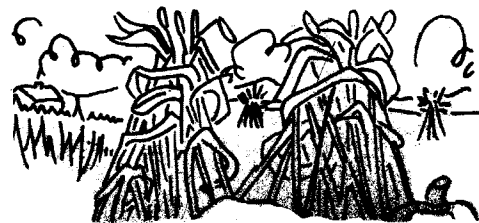

Letter to the Editor

The square dance community has been buzzing since the National Convention in Tennessee. Why doesn't New York State have a costume for the Parade of States and other functions? Why don't we? I haven't heard the answer yet, but perhaps it's time to unofficially start working toward that goal.

The following was suggested which seems simple to execute and uses one state color.

Woman	Man
Top: Light blue (high collar) peasant blouse	Light blue shirt Navy blue slacks
Bottom: Navy blue one tier (outside ruffle) skirt	
Shoes: White	White shoes
Petticoat: Light Blue	White tie

Like it? Please send or phone comments and suggestions to:

Audrey Pankratz
9 Hillside Drive
Fairport, N. Y. 14450
223-2779

Maryln Tailey
428 Johnson Rd.
Bergen, N.Y. 14416
494-2102

Zipperless ^{S/D} dress pattern

2 Lovely Styles!

View A has 3 overlapped skirt ruffles; View B has neckline ruffle, circular skirt with bottom ruffle. Both styles are pullover, with elastic waist and neckline. Shaped belt included.



Newest

Sewing booklet with instructions for making 6 different square dance skirt styles.



Multi-sizes

(6-8-10-12)
(14-16-18-20)

\$3.25+
\$1.00 P.S.T.

\$2.00. For complete pattern catalog add .50¢



TUES & THURS EVENING 7-9
WED. THURS & SAT 11-4

Shirley's S/D Shoppe
Route 9-D
Hudsonville, NY 12537

315-483-4334

BLANCHE ROBERTS
8616 GREIG ST.
SODUS PT. N.Y.

CAKES

ALL OCCASIONS

SPECIAL CAKES FOR SPECIAL PEOPLE
YOUR DESIGNS OR MINE REPRODUCED

ALSO
EASTER CANDY.

MEMBER GENESSEE DANCERS

Contra
Corner



Last month I mentioned Art Teamerson's square dances in Riga. Art's dances are lots of fun---and he works with his own band. These square dances have been going some 25 years or so and while the dancers have changed over the last couple years---the dances are still the same. Art specializes in the singing calls popular in the 40's and 50's---known to some of us as "eastern squares". Many of the dances were also being called at the time by Floyd Woodhull's group in Elmira, New York. No prior knowledge is really necessary---new people take the #4 position in the square. The action of most of the squares is progressive. Couple #1 leads to the right (or whatever) working with the #2 couple, then the #3 couple, etc. It's a real fun night for couples looking for weekend dancing. Dancing begins at 9 p.m. which gives you time to go out for dinner before the dance. (Ed and I like to have dinner in Churchville.) The other feature of Art's dances that I especially like is the "round dancing". Actually, it's ballroom dancing---with the lights dimmed---between the square dance tips. The music? The tunes of the 40's mostly, but the foxtrot---jitter-bug---waltz and polka.

While dancers usually come as couples and there is not much mixing---Art always does patty-cake polka, or some other "mixer" towards to beginning of the evening before a break. Last year there were some high school students there---but generally it's a 40+ age group.

Riga dances are held at the Congregational Church at the intersection of rounts 36 and 33A from 9 to 12 midnight. The schedule this year is November 6th and 20th; December 4th and 18th; January 8th and 22nd; February and March 5th and 19th and the last dances of the season April 2nd and 16th. Square dance clothing can be worn---but any kind of street clothing is okay. It's for you---and your friends and neighbors. Make up a square and join us in Riga! Try some "Traditional" dancing---just for the fun of it!

For more information, phone Art Teamerson at 342-9018.



LET US HELP YOU TURN YOUR IDEA INTO A BEAUTIFUL BADGE

Custom Engraving Service

45 BELLINGER DRIVE
TONAWANDA, NEW YORK 14150
TELEPHONE: 716 692-2727

Have Machine - Will Travel

"The Badge Masters" - Don and Fran Clark



BADGES FOR ROUND AND SQUARE DANCERS

FRATERNAL ORGANIZATIONS

C. B.'ers

BUSINESS -- INDIVIDUALS



MOVING?

Please notify us of an address change 4 weeks in advance. The P. O. will not forward 3rd Class Mail. Each PROMENADER returned to us costs us 25¢.

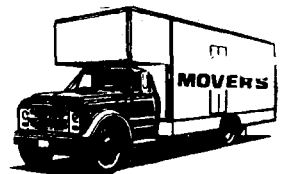

CLUB



NEWS

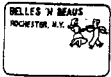

Belles & Beaus

We are happy to report that we had a good turnout for open house both evenings. Everyone seemed to enjoy themselves and 19 couples showed up for class night.

We are happy to welcome back Harold and Hazel Conklin after a long absence and wish you continued good health.

Seven couples camped with the National Hikers and Camper's Association and many more came Saturday evening to help them square dance with Chuck Prister as our caller. He kept us dancing all evening. John and Vera Sellick, Ed and Doris Haddleton and Art and Catherine Widman were asked to judge their personality contest. Everyone enjoyed themselves immensely.

The Jim Patrick-Maxwells and the George Thrashs became grandparents of baby boys the weekend of October 1st. Both babies weighed in at 7 lbs. 14 ozs. and both were 20 inches long. Congratulations to all.

Information
227-3594

Reporters,
Art & Catherine Widman



Boots n' Slippers

We are excited about the turnout that Boots 'n' Slippers had for our open house and Apple Festival. A good time was had by all. By now our new class, taught by Jack Sadwick, is progressing very nicely.

Boots 'n' Slippers would like to extend many, many good wishes to Bob and Alice White who have now made their home base in Vero Beach, Florida. They have been members for many years and we will miss them. We hope they will come back and visit us when they can.

As Thanksgiving fast approaches, we are thankful for all the many terrific people we have met through square dancing.

Information
392-9587

Reporters,
Blair & Pat Johnson



Cloverleaf Squares

As reporter for Cloverleaves, I'd like to say thanks for those coming to square up and for those of you who couldn't make it, you missed a great time.

We would like to congratulate Barbara Siebert and Bill Packard on their engagement and also Kathy Stockmaster and Mike Dunn.

On November 7th we are going to have our nominations for officers and November 28th will be election. Also on the 28th we are having a Thanksgiving Dinner Dance with our class.

We would like to thank Joe Sweeney for the hayride at his family's farm. We had an old fashioned great time.

On November 14th the Tecumseh Squares will be our guests and the following week we will have the Triggers as our guests. We hope they will have an enjoyable dancing evening.

Information
352-6379

Reporter,
Laurie Gavigan



Copy Cats

It was great to have Mike Callahan back for our October dances and to be dancing with all our guests. We are delighted to have guests join us and invite them to come often.

On November 13th we will have a Potluck Supper with Mike Callahan calling and Gordie Copeland cueing rounds. We would enjoy having guests. Bring place settings and a dish to pass.

Our guest caller on November 27th will be Richard Casper with Mike Herne as cuer.

Mark your calendars for our Christmas Dance on Saturday, December 11th with Mike Callahan calling and Bob Slomcenski doing the rounds. It will be held at Ontario Firemen's Exempt Hall on Route 104. It is open to members of all classes and clubs. Dinner reservations are requested.

Happy Thanksgiving to all.
Information
377-6119

Reporters,
Joe & Effie Wysocki



Country Dancers

This years our club is continuing the 7-8p.m. workshop in series form started last spring with clogging instruction. In October Mike Leach started teaching the waltz and polka giving the basics for "turning dances". I'm sorry I couldn't make the October PROMENADER to get this information to you. However, for those of you that can do turning dancings, you might like to learn the Swedish Hambo which will be taught on November 4th and 11th from 7:15 to 8 for \$1. If time permits, Schottisch will also be taught. Later in the season we hope to have some English dance workshops and maybe a few teaching old tyme rounds (Laces and Graces; Road to the Isles; St. Barnard's Waltz and others.) I will try to keep you up to date--but call me if you are interested.

We are also thinking ahead to Dance-O-Rama next spring. Do you want a contra hall? Do you want a contra workshop (all the contra basics taught)? It would take one to two hours. Do you want live music for some of the evening dances? Please give me your suggestions---we need to hear from you.

244-1375

Barbara Butenhof

Hilton Hillbillies

Now that all you ghosts and goblins had your fun it is time to get down to business. Let's talk turkey. Yes, we may be a teen-age group and we may bump and grind when we are in a square of teen-agers but when we have adults in the square we dance the way we were taught. Even though we are teen-agers, we do have manners. And, of course, we like guests and we Need guests. Note: That's we NEED guests. Come and join in on our fun. On November 6th and November 20th we hope to see as many adults as possible at our dances.

Information
352-5564 and 392-8054

Your Reporter,
Jacqueline Herne



Country Twirlers

Thanks to Dan Dedo and Bud Redmond for two great dances last month. Members and guests all had a good time. We are looking forward to November 19th when Bruce Shaw will be our guest caller with Bob Slomcenski cueing the rounds.

We welcome back all past members and want to give a special welcome to all those who have joined our club for the first time.

The Country Twirlers will have a New Year's Eve Party at St. Helen's School Hall. Jack Barnes will be with us to call the dance. The party will include a Midnight Celebration and buffet lunch followed by an after party of fun and skits. Tickets will be sold to members only until November 27th. After that date all dancers are welcome. Call Dot & Herb Scheg (889-4575) or Janet & Tom Johnson (621-8472) for reservations. Tickets will be limited to the capacity of the hall.

Another evening of guaranteed fun and good dancing is planned for December 4th when Gloria Roth will be our guest caller. If you enjoyed her at D.O.R. (and the National Convention) you'll love her at Country Twirlers.
 Information Reporters,
 247-7259 Ken & Kay Georger

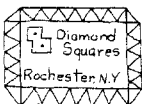

Diamond Squares

The Fall season is upon us and what better way to warm up those chilly evenings than by dancing with the Diamond Squares. Dances are held every Wednesday evening with Saturday night specials on the first Saturday, Dottie & Jerry Reed cueing. Come and join us for an evening of fun and great dancing.

Bob Ellis will be holding a Plus Level Workshop (formerly called Plus 1 & 2) on Tuesday nights starting November 2nd at the Trinity Episcopal Church, 3450 Ridge Rd. West from 8 to 10 p.m.

Those couples who attended Rainbow Weekend had a real good time, lots of dancing, fun, skits and a little magic by our disappearing caller. We even had a couple of flashers - right, Jeannette?

We wish lots of luck to Hank & Marge Nasella who will be leaving the club to move to a better climate. They have been with the club since it originated and they will be missed by all those who know them.

A belated Happy Anniversary to Bob and Nancy Ellis who celebrated their 7th anniversary on September 30th.

Happy Thanksgiving to all.

Information Reporters,
 225-7246 Jerry & Joan Sanford



Henrietta Friendship Squares

We started our 1981-82 season with a well attended open house. Special guests visited from Switzerland, Australia and Canada. We were especially pleased to see all of our precious members out to dance with us. We welcome you all back to our club and hope you can attend our dances often.

Our new class is progressing rapidly, thanks to Ron & Betty. Angels are always welcome to our class to help out.

Happy Thanksgiving to all our friends.

Information Reporters,
 334-9580 Dick & Donna Generas



EKC-O Squares

Hi Square Dancers!

By now everyone should be back in step for round and square dancing!

We have a nice class started this year and look forward to meeting and helping them get to know and like a great national pastime (square dancing).

Bud Redmond has been calling "good" dances, so if you haven't been dancing with us for a while, come try us again and see for yourself.

Betty Wolcott is doing her usual great job of round dance cueing and Jack Sadwick is keeping the class equally enthusiastic.

We also have three German men, working at Kodak for a year, that would like to learn to square dance. We need women volunteers to dance with them each week. (They are eager learners).

I have to apologize for not including Pat and Marlene McMaster (our Treasurers) in last month's list of officers. So, we give many, many thanks to them for sitting there week after week to collect all that needed money and ring their bell for those of us who are getting old and forgetful.

Bud & Claire Young were back dancing with us and it was nice to see them again. Claire has been ill and it was great to see her able to be with us.

If anyone knows of someone who has been ill or just hasn't been able to dance for awhile, invite them back to visit us. They could just discover that they haven't forgotten as much as they might think they have and they might enjoy getting back in step with old and new friends. See you dancing!

Information Reporters,
 392-8713 Bud & Joan Engelbrecht



Glass Slippers

The Glass Slippers invite all our friends to join us at the Sweden Senior Center on Wednesday, November 10th for our annual wine and cheese party. The Center is located at 133 State St., near the General Electric plant. You're sure to have a good time that night.

On November 13th we're going on our first Mystery Ride. Dick and Sue are not even giving us a hint.

We're happy that Sue Palmateer and Esther Knab are now dancing some of the tips. Carl Wass seems to be fully recovered from his leg's collision with the tractor crank. Arlene & Nick Caputo are also back. Dancing with all our friends is such a pleasure.

Our class is full of enthusiasm and they're catching on quickly. Maybe that's partly because there are so many angels around ready to fill squares. The learners have discovered Rule Numero Uno: Listen to the caller.

Please mark this date on your calendar: January 29, 1983. The Glass Slippers plan another Country-Western Celebrity Night at the Cooper Center of Brockport State College, otherwise known as the Campus School. Arrangements are nearly completed for another great night of dancing, fun and food.

Happy Thanksgiving from the Glass Slippers to all our dancing friends.

Information Reporter,
 637-4755 Elsie Epke



Geneva Friendship Squares

On August 23, 1982, Dorothy Niles, one of the Geneva Friendship Squares most active and supportive members, passed away. All who knew her share in the loss that her family is feeling today. Our annual cancer dance, to be held on March 11th, 1983, will be in her memory and all proceeds will go to the Cancer Research Fund.

Our Sauerkraut Festival Dance, held on August 7th in Phelps, New York, was again a huge success. We had 57 couples dancing under the stars to Dick Casper calling and Al Overslaugh cueing. Jack and Rose Smith from Newark's Kuntry Kuzzins won the Grand Prize. It was a ticket to our Sampson Fall Festival which also was a huge success. We had 125 couples in attendance. Our staff this year consisted of Jerry Carmen and Red Bates calling and Bob and Nora Slomcenski cueing the rounds. We might add that our festival would not be the success that it is if it were not for all the hard work on the part of our Chairmen, Lee & Jackie Pratt and all of their Committee Chairmen.

The week after the Festival five couples from our club traveled to Lake Placid to attend the Flaming Leaves Festival. A good time was had by all.

Don't forget our Marshall Flippo dance on Monday, November 8th from 8 to 10:30 p.m. at the new Geneva Senior High School located on Carter Road. The price of the dance is \$4.50 per couple.

Hope everyone has a healthy and Happy Thanksgiving.
Information Reporters,
789-2961 Bill and Donna Hiron



FOR YOUR DANCING PLEASURE



WESTERN PANTS
WHITE-COLORED
EMBROIDERED
SHIRTS
TIES-BELTS
BOOTS-SHOES
ALL ACCESSORIES

SKIRTS-BLOUSES
DRESSES-SHOES
PETTICOATS
PETTIPANTS
JEWELRY

NEW ARRIVALS FOR FALL

DRESSES & SKIRTS

Parking Now Available in
Front of Store

Discount with Club Badge

Shop Early for Christmas!!!

WENIGER'S 124 SOUTH AVE.
232-2482

9:30-5:30 MONDAY-FRIDAY
9:30-4:30 SATURDAY

PARK FREE AT
SOUTH AV. RAMP GARAGE



Genesee Dancers

The Genesee Dancers hope you are having a good fall dancing season and wish you a great Thanksgiving. Our Hallo-weenie Roast on October 28th was great fun for all who attended. The unexpected visit from the Four Dumbpinski Brothers Plus One was a happy time. This group of five short men is the renowned International Marchers who recently entertained in Niagara Falls, Canada. Our HAT'S off to them!

We welcome Jerry Carmen as our guest caller on November 11th. November 18th will be our Second Annual Turkey Trot Dance. Will George and Shirley Lupold bring their "special guest" as they did last year. (He was very talented - gobbled in time to the music.) Come that night and find out!

Our annual Christmas Dinner-Dance will be held December 9th-mark your calendar and reserve that date. And yes, the club WILL BE DANCING every Thursday in December, including December 23rd and December 30th.

The Genesee Dancers express their deepest sympathy and send their prayers to Jim Cutter and his family on the loss of his wife, Dorothy, in August. Our sympathy, too, to the family of Woody Sherwood, a friend and supporter of the club, who died in September.

Marion and Jack Hoyt are in the Guinness Book of World Records! Although their names are not listed individually, they participated in a record-breaking square dance in a high stadium at the 30th National Square Dance Convention in Seattle, Washington in June, 1981. A total of 18,520 dancers (2,315 squares) danced to caller, Marv K, before about 10,000 square dance viewers to set the official world record for the largest square dance ever. The previous record of 15,200 dancers had been set in 1950.

Bernie & Doris Root were awarded Five Year dangles while dancing at the Fling Fantastic in Niagara Falls, Canada. Before the award, they learned a new dance - "Make me a column"!

In preparation for Ol' Man Winter, dance cancellations will be broadcast on WNYR - 990 - as well as other local radio station. Listening to the radio should be much easier than trying to contact a club officer!

Information
248-2298

Reporters,
Graham & Lorraine Chamberlain



November will be another busy month for our club. Bob Ellis will be our guest caller on the 20th and our annual meeting and tureen supper dance will be on the 27th at the Church of the Transfiguration on Culver Rd.

We are pleased to report the Beginners Club is progressing nicely under the tutelage of Bob Meagher. Members of the club are most welcome at the Thursday night classes. It's a great opportunity to meet the new people now enjoying the world of Square Dancing.

Congratulations to Ed and Ginny Penczek who are the new presidents of the Federation. They are back from their trip to Africa and Southern Europe. On the subject of travel, Ed and Marge Anderson toured the Pacific Northwest and the Canadian Rockies in September and Bob and Lil Cunningham went to Canada and Michigan in their motor home. The Cocos, Menzies, Nicolettis, Richmonds, Salvaggios and Shuberts enjoyed the Fling Fantastic in Niagara Falls, Canada.

Remember to keep our special dances open. They are our Poinsettia dance, Dec. 18 and our New Years Eve dance.

Information
342-0474

Reporters,
Ken and Mary Jane Nudd

SALLY'S SQUARE LINE

530 Washington Ave. — Rochester, New York 14617

Please Call (716) 342-1561

EVERYTHING FOR THE ROUND & SQUARE DANCER



SEE
SALLY J. SOLTYSAIK
FOR
PERSONAL TOUCH

House
of Western Fashions

WE SELL
Encyclopedias



Custom Dresses
Fluffy Petticoats
Ladies Coats
Books for Beginners

BARGAIN RACK

Always Some Mark-Downs

SHOES

Magestic & Dancers
Slight Irr. \$14-\$15



Square Dance Clothing & Accessories
DISCOUNTED PRICES



Sales Slip No. 6
Please pick up your
\$5.00 gift certificate

Happy Thanksgiving!

Very Large Selection
Blouses, Skirts & Dresses
Shop Early for Holidays

Open House Classes
November 7th 2 to 5 Sunday
(Announce to your classes)

Open House
Club & Class
Sunday, 2 to 5 p.m.
December 5th

We will be carrying Border Patrol Patterns.

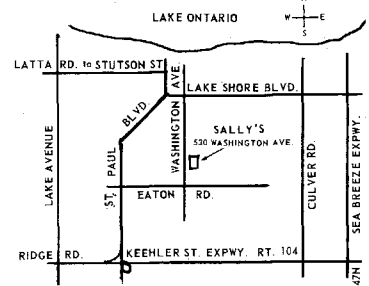

Kuntry Kuzzins

Kuntry Kuzzins will sponsor Bob Ellis as caller and Mike Harris cuer on November 13th at Kelley School, Newark, N.Y. 8p.m.

Then on November 27th Bruce Shaw will be calling squares and Dottie Reed will cue rounds.

Several of our members enjoyed the National Square Dance convention in Detroit and look forward to next years convention.

We all thank the Reeds for the fine decorations at our dances, and others that help out to make the dances at Kuntry Kuzzins fun to attend.

Kuntry Kuzzins have a big special dance coming in December. Jim Lee from Canada will call on Dec. 11 at our Sno-Ball dance. Save this date for a real fun night.

Information Reporters,
(315) 331-5789 Don and Alice Hyman

Lima Grand Squares

We enjoyed our demonstration dancing for the October-fest held at a local church and a Special Thanks to Dick Casper for calling. Our class has begun and we have six new couples.

Please save the date November 19th for our Harvest Dance. As always, everyone is welcome.

Have a happy and blessed Thanksgiving.
Information Reporters,
346-3836 Bob and Jean LaBore



PLUS LEVEL WORKSHOP
(Formerly PLUS 1&2)

The next plateau from Mainstream

Tuesday Nights

starting Nov. 2

TRINITY EPISCOPAL CHURCH

3450 Ridge Road West

8-10:30

\$4⁵⁰ cpl.

Bob Ellis calling





A-1 PARTY SUPPLIES



1278 Dewey Av., Rochester, N.Y. 14613
Full Catering Service-WE COOK, YOU SERVE
Discount to Square Dance Club Members!!!

We supply everything but the guests. Let us help you plan your party now!

Complete paper goods
Decorations & favors



Al & Lucie Joseph
254-2576



Magic Squares

We are really getting back in the swing of things now. Our Open House was October 1st and we packed our hall. The cooler weather has everyone up and dancing. New mainstream classes began on October 8th at 7 p.m. Right after class, at 8:30 p.m., our club dances until 10:30p.m. We dance the Plus Program Level so come and join us every Friday night at the Canandaigua Methodist Church. Helen and Arvin White have taken off in their camper to dance in other states for the next few months. Last month we had a couple from Germany come to dance with us. It is lots of fun to dance with other clubs and to have other clubs come to dance with us. Halloween found us trying to dance smoothly while some of us danced with ghosts and others danced with monsters.

The only Friday in November we won't be dancing will be November 5th.

You'll need to dance on the 26th to compensate for all the overeating you did at your Thanksgiving table. Good exercise - Good Fun - Good food.
Information Reporter,
394-8295 Joyce Connor



Merry Mixers

Our summer class has come a long way in a short time. Some of them even danced in demonstrations at the Zoo Fest. Now they have joined us at our club time, and we have a brand new class. It's great to see so many people out having such a good time.

Our congratulations go to newlyweds Bob & Shirley Centola Atwell who were married this summer.

Dancers from other clubs are always welcome to join us - remember that "Happiness is dancing with the Merry Mixers."

Information Reporter,
338-1080 Nancy Donald



The team of Harris and Mattice will become the team of Harris and Harris. Jody and Mike have announced their engagement and set July 4th, 1984 as their wedding date.



Morton Country Swingers

Ten couples traveled to St. Catherines, Ontario on 9/25/82 to enjoy the Grape Festival. The Morton Country Swingers watched an enjoyable parade, sampled the wine, and danced with the St. Catherines Pioneer Squares.

The Fall Festival dance was a success on 10/9/82, guest caller Dave Moss provided our many guests with fine dancing. We hope everyone had as much fun as the Morton Country Swingers.

The Grand Swinger is preparing to welcome the Hilton Boots and Slippers and Fairport Village Squares at our 11/18/82 dance. We look forward to hosting these fine clubs.

The Morton Country Swingers conferred the Legend of the Grand Swinger on several couples at our 10/14/82 dance. These new dancers qualified by attending three regular dances. Certification and the Counter Sign were conferred in an inspiring ceremony by the Grand Swinger.
Information Reporters,
(716) 964-3639 Bruce and Joan Hilton

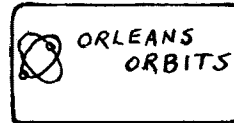

We're all looking forward to our Apple-Fest on Sat. Nov. 6. We expect it to be bigger and better than last year - so come join us for an evening of fun. Congratulations to Karl and Doris Schuner who celebrated their 40th Wedding anniversary with an Open House on Oct. 17. We also wish a speedy recovery to Ray Corser who had not one, but six-bypass surgery. At last report he was coming along fine and we hope he continues to improve so he can be back with us dancing on Saturday nights.

Information Reporters,
(716) 772-7125 Clare and Rosemary Gilbert

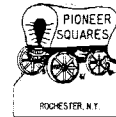

Pioneer Squares

Welcome back to our club members who have been vacationing. Our world travelers, Presidents Ray and Dorothea Brayer from China; Sherm and Marianne Montgomery and Joe and Marie Leone from Hawaii. I'm sure they will have many stories to tell and some very interesting pictures to show. Glad to have everyone back dancing!!

Our dances for November will be the 12th and the 16th. Our caller, Jon McNally, has put together a special program for the night of the 26th. He wants to give all of us a chance to work off the extra calories we consumed on Thanksgiving Day. Jon (Richard Simmons) McNally!!

We look forward to seeing many new faces at our dances, former club members and those who just haven't danced for awhile.

Information Your Reporters,
544-6231 Joe and Marie Watro



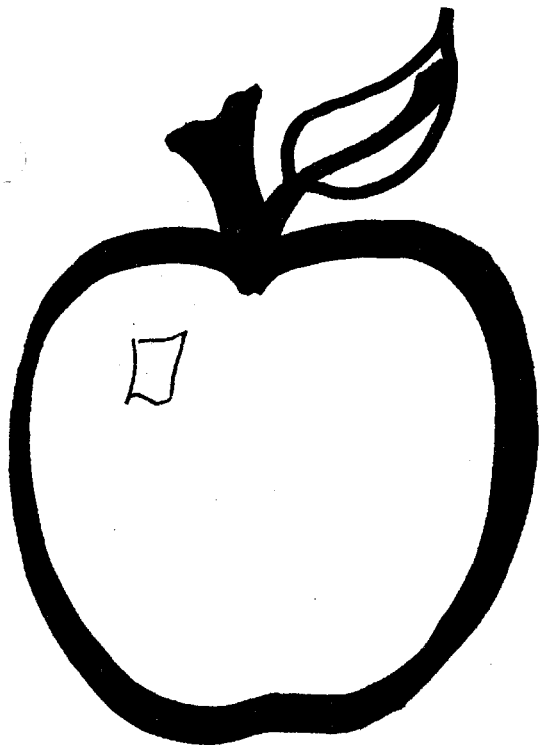

DANCE

8-11 p.m

Nov. 6th
(SATURDAY)

Applefest

Pies

Cider

Kuchen

Apple
Everything

ORLEANS ORBITS

"Ron" Fotch
-calling-

Medina Y/MCA

Pearl St. (Rt. 63) off Rt. 31

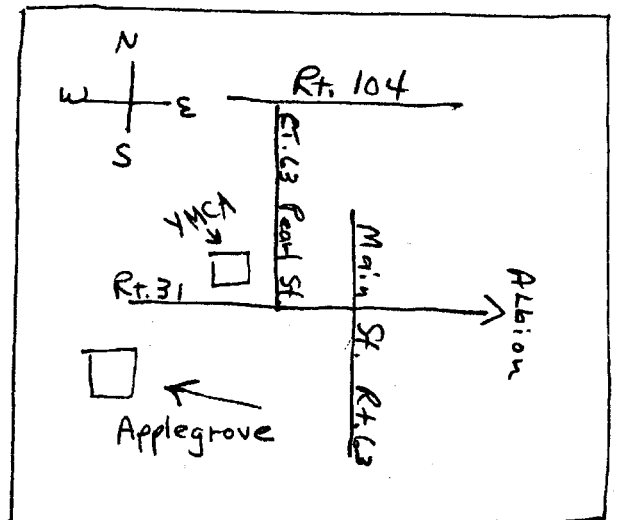

BOB & NANCY ELLIS present ...
 New Year's Eve
SQUARE DANCE PARTY!

Plus
 Level
 Dancing



Plus
 Level
 Fun

\$ 30.00 per couple by Reservation only
 BUFFET DINNER at 9 PM ~ DANCING 'til 2AM
 HATS & NOISEMAKERS

BOB ELLIS DOTTIE REED

Send Reservation to... NANCY ELLIS 4564 Yautzy Road, Stanley, N.Y., 14561



Promenading B's

Come one, come all to the B's Annual Turkey Raffle to be held on November 19th. There will be a fantastic variety of baked goods and prizes donated by all our busy B's. Of course there will be a quantity of the "big birds", too. Plan to join us for a fun evening.

November 5th will be our Mystery Ride, not even the caller or the bus driver (the same generous guy) knows where we're headed. Frank Van Duesen (our President) is giving the directions as we travel. We're not sure if that is good or bad!

November 12th we will be honored to have Myron Huss as as our guest caller. Let's have a great turn out for him. It sure will be nice to have a chance to dance with Betty and Ron. (Do you suppose a caller makes mistakes when he dances?)

There will be no dance on November 26th. On behalf of all the members of our club, we would like to take this opportunity to wish all of you a very happy Thanksgiving. We'll see you all back dancing on December 3rd to dance off all those calories.

Information
 548-9958

We'll "buzz" off for now,
 Larry & Norma Belluscio

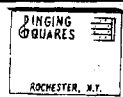

Singing Squares

IT IS WITH DEEPEST REGRET THAT THE
 "SINGING SQUARES" WILL NO LONGER DANCE
 AS A CLUB. OUR FINAL DANCE TOOK PLACE
 WEDNESDAY NIGHT, SEPTEMBER 22, 1982.

Fun Luv'n' Squares

Hear Ye! Hear Ye! Halloween has come and gone, the leaves on the trees have flown, the holiday deason is almost here and the school district has PROMISED not to spring any more surprise cancellations upon us.

November brings us thoughts of special festive dinners, buying gifts, visiting family members, heavy snows, (bite your tongue, Ed.) poor heating bills, record cold and so on. With the mind working so hard, concentrating on so many things at once time, you really don't need to have to think about your dancing, too.

Dancing should be fun and here at FUN LUVIN' that's what we try to provide. We call it Mainstream with some pleasant variations. Variations like: smoothness of flow, dancing the calls by definition, Mike's pet call of the night. We have dancers of all ages from teens to grand-parents like myself and they all seem to smile. Hmmm... maybe we're doing something right.

Come on over to 12 Corners Middle School on Wednesday nights and bring another couple or two with you, but beware: Smiling while dancing can be contagious and you will probably want to return. See you Wednesday!!

Information
 288-1287

For Fun in Dancing,
 Granny Rytenlef





Swingin' Eights

The leaves are falling and the mood swings towards autumn. By the time this issue is printed we will have celebrated our annual Halloween Dance together with the Irondequoit Squares with it's weird costumes and revelry and everyone in the right spirit.

The Reisingers are leaving for a tour of China and we can't wait to hear about their adventures. On November 13th, Mike Herne will be our guest caller and it should be fun. You all join us.

Information
266-3667

Reporters,
Al & Sarah Lichterman

Swinging Squares

Greetings from the Pre-Teens!

Our club ranges in age from 7 to 13 years old. We're the only kid's club that we know of in the area and we really enjoy square dancing.

Our caller, Les Bratt, is very nice and he makes our dances fun for us. He is also very patient with our 3 squares of new class people.

We dance at the Lutheran Church of the Concord on Holmes rd. in Greece every Saturday afternoon at 2:00 p.m. Come on over and watch us sometime and maybe join us for a tip. (We don't charge for adults.)

Information
964-8985

Dancing is fun for everyone!
Sarina Herne



Swinging Singles

'Tis the season to "Fall into Swinging Squares". Fall is "Harvest Time". "Angels" should encourage the class to hang in there and soon they will "reap" the benefits.

On October 9th we had a bike ride along the canal and enjoyed the fall foliage in all it's splendor.

The "Great Pumpkin" arrived on October 28th. The club/class Halloween costume dance was held at that time. We showed-off our creative talents as we got acquainted.

Class/Club will enjoy the "Fruits of the Harvest" at our dinner/dance on November 22nd. We will begin to "Feast" at 6:30 p.m. followed by some "Swinging Squares".
Information
(315)986-6727

Reporter,
Cathy Morton



Wayne Westerners

Our annual Halloween Dance at the Lyons Nursing Home was as enjoyable as ever. Guiding the patients, in their wheel chairs, through the dances is always as much fun for us as it is for them. We want to again thank the staff for their help and for the delicious refreshments; the Halloween cakes are always a work of art.

Our guest callers for November will be Mike and Mary Jane Herne. These two people are very special friends of the Wayne Westerners and are always fun to dance to.
Information
589-8535

Reporters,
Frank & Linda Clark

759 WASHINGTON AVE.
ROCHESTER, N.Y. 14617
266-5720

BILL AND JUDY'S
IRONDA
SQUARE DANCE SHOPPE

REGULAR
HOURS
TUES. THRU
SAT.-10 TO 3:00
TUES. & THURS.
EVE - 7 TO 9

FREE - REFRESHMENTS - FREE

HOLIDAY OPEN HOUSE
SUNDAY, NOVEMBER 21, 1982
2:00PM TO 5:00PM

Special Open House Sale

ONLY TOP QUALITY MERCHANDISE SOLD

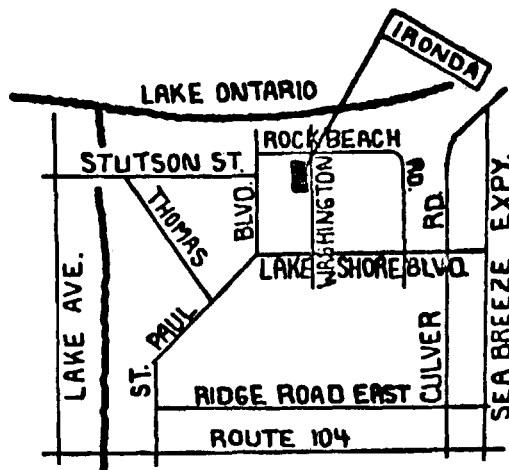

HAPPY THANKSGIVING - LET US ALL BE
HAPPY AND GIVE THANKS FOR OUR MANY BLESSINGS



WEB SPINNERS

INVITE YOU TO DANCE TO THE CANADIAN



NORM WILCOX

FRIDAY

NOVEMBER 12TH

8:00PM

PLANK RD SCHOOL

PLANK + SCRIBNER RD WEBSTER

\$5.00



Tecumseh Squares

The Tecumseh Squares class for 1982-83 is swinging into high gear. All 12 couples are moving right along with Jack Sadwick at the microphone. Congratulations to our membership for bring out a great group!

The October Halloween dance was a big success. Many ghosts and goblins were flying through the dance hall. Who were the mystery couples? They seemed to pop up in a square and disappear a little while later.

Two big events are on the calendar for this month. Of course, we continue to dance every Tuesday night with both rounds and squares. On November 16th we have our annual Gourmet Dessert Night. The desserts are always overwhelming and tasty. You won't want to miss this one. On November 23rd we have a guest caller taking the dancers through a fun-filled evening.

Be sure to join us in all the fun!

Information
Kay 475-2368
Bill 475-6644

Reporters,
Bill & Kay DuBois

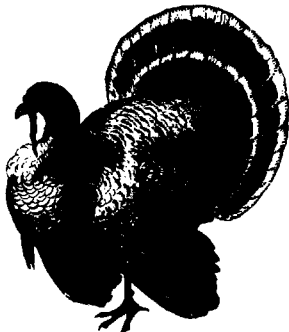

Triggers

On October 12th at 6:45 p.m. at Parkland School, we welcomed new class members. Mike Herne, our caller, is their teacher.

Mabel Wordingham is our very capable Social Chairperson this year. She will use her expertise on November 23rd at the special pie night and guest night. Please join us.

On Election Night, November 2nd, there will be NO DANCE.

Our traveling members are: John and Paulette Bo and Ruth and Jim Appleton who had a fun-filled weekend in Olean dancing to callers Jim McQuade and Jack Barnes. The Raymonds returned from an exotic Hawaiian holiday and the Britts and the Pierces enjoyed beautiful scenery while camping at Cape Cod.

We wish Henry Allen, our newest retiree, all the happiness and blessings retirement can bring.

Ruth and Bill Fitzgerald joined us for an evening of dancing, having been absent from the Rochester area for five years. Hope they will do so again.

Happy Thanksgiving to everyone. We all have so much for which to be grateful.

Information
467-8619

Reporters,
Bob and Mary Speer



Say you saw it in the 'PROMENADER'!

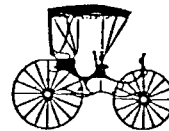

We are Giving "THANKS" for our Wonderful Customers at

The Carriage House Square Dance Fashions



STRAWBERRY SQUARE
MUTTON HILL RD,
AUBURN, N.Y. 13021

(315) 252-9486 OR 252-8410
HOURS THURS. & FRI. 6-9PM.

SAT. 9AM.-2PM.

OR CALL FOR AN APPOINTMENT

"Your Complete Square Dance Shop"

TRAVELING SHOP - MAIL ORDERS

VISIT US at
SPINNING WHEELS PORT BYRON NOV. 13th
AND SHIRTS & SKIRTS FULTON, N.Y. NOV. 19th

NOVEMBER SPECIAL 10% OFF
ON ANYTHING BLACK
PURCHASED IN OUR STORE



Do-Si-do with Style

GET IN ON THE FIRST ROUND - ORDER YOUR
 SQUARE DANCING T-SHIRT NOW 50/50 COTTON & POLYESTER
 NAVY BLUE AND RED WITH WHITE LETTERING

*Kids
 Printed
 T-Shirts
 only
 \$4.95*

*Adults
 Printed
 T-Shirts
 \$ only
 5.99*

ADULT	S	M	L	XL
	34-36	38-40	42-44	46-48
CHILDREN	S	M	L	
	6-8	10-12	14-16	

HAPPINESS IS BEING



A SQUARE DANCER

WE ALSO PRINT
 BASEBALL HATS, JACKETS, SWEATSHIRTS
 AND T-SHIRTS FOR SPECIAL ORDERS IN
 MINIMUM QUANTITIES.

DELIVERY CHARGES INCLUDE
 SHIPPING, HANDLING, INSURANCE
 AND DELIVERY

1-2 SHIRTS.....\$1.99
 3-4 SHIRTS..... 2.50

FOR FURTHER INFORMATION PLEASE CALL CENTRE SPECIALTY
 (716) 266-6635

QUANTITY	SIZE	PRICE	TOTAL

SEND MONEY ORDER OR CHECK TO:

CENTRE SPECIALTY
 P. O. BOX 17712
 ROCHESTER, NEW YORK 14617

ALLOW THREE WEEKS DELIVERY

Sales Tax

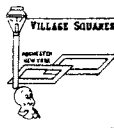

Village Squares

HOLIDAY FASHIONS & DANCE

Saturday, December 4

8-11 pm \$4.50/cpl.

COVENANT UNITED CHURCH
Culver Road & Parsells

BOB ELLIS squares DOTTIE REED rounds

fashions by- THE CARRIAGE HOUSE
Auburn, New York

presented by- THE DIAMOND SQUARES

level- PLUS LEVEL
PLUS FUN

This year we have a fine new class of thirteen couples and they are showing lots of enthusiasm. Mike Harris is doing an excellent job of instructing them and even the angels are having a good time.

On Monday nights we've enjoyed dancing with our many guests and hope they will continue to drop in. The more the merrier.

Jody Mattice has started as our round dance cuer and is doing a great job. Some of us feel that we have two left feet for this type of dancing but Jody has a lot of patience. Rounds begin at 7:30 and squares at 8:00.

There are three squares in the A-1 group on Tuesday nights with Dick Casper. They are all working hard and having fun. All A-1 dancers are welcome.

Two special events are on the calendar for this month. On November 1st we'll have our Mystery Ride. We hope to have a good turnout to see where our ride will take us.

Our Banner Dance will be the following Monday, November 8th. We're looking forward to having all the clubs come to retrieve their banners on the 8th. Let's have all of our members on hand to welcome them with the usual Village Square's enthusiasm. It will be a fun-filled evening of good dancing and everyone is welcome.

Our Christmas dinner dance will be on December 13th and will require reservations. Be sure to save that date.

Information Reporters,
377-3255 or 381-2191 Chape & Jean Blake

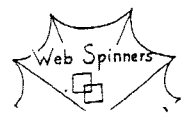

Web Spinners

Our month for Turkey, Dressing and Pumpkin Pie. The Web Spinners are in full swing now with a good class working hard and our caller, Bill Wilcox, trying all sorts of "new things" on Friday nights.

Speaking of our class, we want to make a special note on two gentlemen look-a-likes; none other than John Straube and his dad. The dad being the class member and John, the Angel. We think that is a "pretty special" switch!

A group of Web Spinners enjoyed taking advantage of the Fall Fling at Niagara Falls and the Flaming Leaves Festival in Lake Placid. All reported a good time.

A wedding was held this summer that we missed reporting in September. Our hearty congratulations to Ray & Mo Gibb!! Would you believe the Farraras have another wedding this month? This means all three of their kids married in the same year! Enjoy your "new world", Jack and Betty, now they can all come home for Thanksgiving Dinner!

A special thanks to Jim and Claudette Looney and committee for our nice Octoberfest. Our November activities include an All Singing Calls Night, November 5th - guest caller, Norm Wilcox, November 12th - Guest Night with guests from Belles & Beaus, Copy Cats, Glass Slippers, Kuntry Kuzzins and EKCO Squares, November 19th - NO DANCE on November 26th.

Let's count our blessings this Thanksgiving, I'm sure we all have many to count!

Information Reporters,
265-3763 Dave & Sherry Pierson

Promenading B's

THANKSGIVING SPECIAL



Fri. Nov. 19 - 8 pm

Our caller. . . . "Ron" FOTCH

Come, get your share of:
Turkeys - fruit - pies - baked goods
Square dance accessories

Byron-Bergen Elementary School
W. Bergen Rd. (off Rt. #262, 4 Miles
west of Rt. #19, Bergen, NY)

Patronize our advertisers -

THE 6th January

JUBILEE



MAINSTREAM PLUS II

ADVANCED & CHALLENGE

Featuring

Bob Gambell
Keith Gulley
Lee Kopman
Steve Kopman
Ron Libby
John Marshall
Norm Poisson
Ron Schneider

Rounds :
Ron & Ree Rumble

JANUARY 13, 14, 15, 1983
PHILADELPHIA CENTRE HOTEL
PHILADELPHIA, PENNSYLVANIA

ADDITIONAL INFORMATION

Lee Kopman (N.Y.) 516-781-4164
Vince Dimick (PA.) Program . . . 215-379-8634
Dacie Babb (Del) Publicity 302-475-8093
Jan Laird (MD.) Registration . . . 301-390-6477

Please make your own hotel reservations

HOTEL RESERVATIONS

6th JANUARY JUBILEE — JANUARY 13, 14, 15, 1983

MAIL TO: THE PHILADELPHIA CENTRE HOTEL
1725 JFK BOULEVARD, PHILA., PA 19103

Name _____
(Please Print) LAST FIRST

Street _____

City _____ State _____ ZIP _____

Telephone _____

PLEASE RESERVE: (Circle One)

SINGLE \$42.00 TWIN OR DOUBLE \$47.00

BEDROOM SUITE \$115.00 \$120.00

Minimal Parking Fee Arrival _____ Departure _____

MAKE CHECKS PAYABLE TO 6th JANUARY JUBILEE

MAIL TO: Mrs. Jan Laird
9804 Dubarry St., Glenn Dale, MD 20769
Official confirmation will be forwarded.
Full refund on cancellation until Dec. 1, 1982

REGISTRATION INFORMATION

Name _____

Street _____

City _____ State _____ Zip _____

FESTIVAL FEE:

- \$35.00 PER COUPLE ENTIRE FESTIVAL
- \$30.00 PER COUPLE PARTIAL FESTIVAL
(Friday 2:00 P.M. through Saturday)

CASH CHECK

TYPE OF DANCER:

- Mainstream Plus II Advanced Round Dancer
- Challenge 1 2 3 4 (Circle One)

November

Let's Go Square Dancing



•WHERE•



1982

SUNDAY

7	Cloverleaf Squares Caller's Cooperative Jerry's Funshop	Callahan/Libertis Jerry Carmen	Trinity Episcopal Church, 3450 Ridge Rd. W. United Covenant Methodist, corner Culver & Parsell	8:00 12:00	Nc p.m.
14	Cloverleaf Squares	Callahan/Libertis	Chili Community Center, Buffalo Rd. near 259	7:30	A1&2
21	Cloverleaf Squares Jerry's Funshop	Callahan/Libertis Jerry Carmen	Trinity Episcopal Church, 3450 Ridge Rd. W. Trinity Episcopal Church, 3450 Ridge Rd. W.	8:00 8:00	K K
28	Cloverleaf Squares Jerry's Funshop	Callahan/Libertis Jerry Carmen	Chili Community Center, Buffalo Rd. near Rt. 259 Trinity Episcopal Church, 3450 Ridge Rd., W. Chili Community Center, Buffalo Rd. near Rd. 259	7:30 8:00 7:30	A1&2 E0Z A1&2

MONDAY

1	Belles 'n' Beaus Merry Mixers Swinging Singles Shamrock Squares Victor Swing a Longs Village Squares	Art Harris Mike Harris Jerry/Betty Carmen Mike Callahan Bob Meagher Dick Casper	Holmes Rd. School 300 Holmes Rd. Seneca Methodist Church, 121 Scholfield Rd. Penfield Baptist Church 1862 Penfield Rd., Penfield Summerville Presbyterian Church (see reader ad)	8:00 8:30 8:30 8:00	R8 07 07MPPK A1+
8	Friendship Sq.-Geneva Belles 'n' Beaus Merry Mixers Swinging Singles Shamrock Squares Victor Swing a Longs Village Squares	Marshall Flippo Art Harris Mike Harris Jerry/Betty Carmen Mike Callahan Bob Meagher Dick Casper	Geneva Senior High School, Carter Rd. Holmes Rd. School, 300 Holmes Rd. Seneca Methodist Church, 121 Scholfield Rd. Penfield Baptist Church 1862 Penfield Rd-Penfield Summerville Presbyterian Church (see reader ad)	8:00 8:00 8:30 8:30 8:00 7:00	RPPKJ NJK R8 07M 07MPPK A1+
15	Belles 'n' Beaus Merry Mixers Swinging Singles Shamrock Squares Victor Swing a Longs Village Squares	Art Harris Mike Harris Jerry/Betty Carmen Mike Callahan Bob Meagher Dick Casper	Holmes Rd. School, 300 Holmes Rd. Seneca Methodist Church, 121 Scholfield Rd Penfield Baptist Church 1862 Penfield Rd-Penfield Summerville Presbyterian Church (see reader ad)	8:00 8:30 8:30 8:00 7:00	R8 07 07MPPK A1+
22	Belles 'n' Beaus Merry Mixers Swinging Singles Shamrock Squares Victor Swing a Longs Village Squares	Art Harris Mike Harris Jerry/Betty Carmen Mike Callahan Bob Meagher Dick Casper	Holmes Rd. School, 300 Holmes Rd. Seneca Methodist Church, 121 Scholfield Rd. Penfield Baptist Church 1862 Penfield Rd-Penfield Summerville Presbyterian Church (see reader ad)	8:00 8:30 8:30 8:00 7:00	R8 07 07MPPK A1+
29	Belles 'n' Beaus Merry Mixers Swinging Singles Shamrock Squares Victor Swing a Longs	Art Harris Mike Harris Jerry/Betty Carmen Mike Callahan Bob Meagher	Holmes Rd. School, 300 Holmes Rd. Seneca Methodist Church, 121 Scholfield Rd. Penfield Baptist Church 1862 Penfield Rd-Penfield Summerville Presbyterian Church (see reader ad)	8:00 8:30 8:30 8:00 7:00	R8 07 07MPPK A1+

TUESDAY

2	Tecumseh Squares Triggers R. F. Squares Shamrock Squares Village Squares	Shaw/Libertis NO DANCE Ron Fotch Mike Callahan Dick Casper	Redmen's Party House United Methodist Church, N. Chili (see reader ad) Covenant United Methodist Church (see reader ad) 1st United Methodist Church, Fairport	8:00 7:30 8:00 8:00	MRK RPPK A2+ A1K
9	Tecumseh Squares Triggers Shamrock Squares Village Squares	Shaw/Libertis Mike Herne Mike Callahan Dick Casper	Redmen's Party House Parkland School, 1010 English Rd. Covenant United Methodist Church (see reader ad) 1st United Methodist Church, Fairport	8:00 8:15 8:00 8:00	MRK PP A2+ A1K
16	Tecumseh Squares Triggers R. F. Squares Shamrock Squares Village Squares	Shaw/Libertis Mike Herne Ron Fotch Mike Callahan Dick Casper	Redmen's Party House Parkland School, 1010 English Rd. United Methodist Church, N. Chili (see reader ad) Covenant United Methodist Church (see reader ad)	8:00 8:15 7:30 8:00	MRK PP RPPK A2+
23	Tecumseh Squares Triggers Shamrock Squares Village Squares	Guest Caller (TBA) Mike Herne Mike Callahan Dick Casper	Redmen's Party House Parkland School, 1010 English Rd. Covenant United Methodist Church (see reader ad) 1st United Methodist Church, Fairport	8:00 8:15 8:00 8:00	FMRK PP A2+ A1K
30	Tecumseh Squares Triggers Shamrock Squares Village Squares	Shaw/Libertis Mike Herne Mike Callahan Dick Casper	Redmen's Party House Parkland School, 1010 English Rd. Covenant United Methodist Church (see reader ad) 1st United Methodist Church, Fairport	8:00 8:15 8:00 8:00	MRK PP A2+ A1K

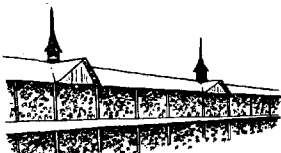

National Square Dance Convention®

Louisville, Kentucky

18.

June 23, 24, & 25

1983

WEDNESDAY

3	Diamond Squares	Bob Ellis/Reed	Green Lantern Inn, Fairport	7:30	RA1M+
	Fun Luvin'Squares	Mike Herne	Brighton 12 Corners Middle School	8:00	MK
	Glass Slippers	Ron Fotch	Ginther School, Brockport	8:00	KØ7
	Which Way Whirlers	Mike Herne	Pavilion Elementary School, Pavilion	8:00	K
10	Diamond Squares	Bob Ellis	Covenant United Church, 1124 Culver Rd.	8:00	A1M+
	Fun Luvin' Squares	Mike Herne	Brighton 12 Corners Middle School	8:00	MK
	Glass Slippers	Ron Fotch	Sweden Senior Center-133 State Street, Brockport	8:00	JKØ7
17	Diamond Squares	Bob Ellis	Covenant United Church, 1124 Culver Ave.	8:00	A1M+
	Fun Luvin'Squares	Mike Herne	Brighton 12 Corners Middle School	8:00	MK
	Glass Slippers	Ron Fotch	Ginther School, Brockport	8:00	KØ7
	Which Way Whirlers	Mike Harris	Pavilion Elementary School, Pavilion	8:00	K
24	Diamond Squares	Bob Ellis	Covenant United Church, 1124 Culver Ave.	8:00	A1M+
	Fun Luvin' Squares	NO DANCE			
	Glass Slippers	Ron Fotch	Ginther School, Brockport	8:00	KØ7
Dec.1	Diamond Squares	Bob Ellis/Reed	Covenant United Church, 1124 Culver Ave.	8:00	RA1M+
	Fun Luvin' Squares	Mike Herne	12 Corners Middle School, Brighton	8:00	MK
	Glass Slippers	Ron Fotch	Ginther School, Brockport	8:00	KØ7
	Which Way Whirlers	Mike Harris	Pavilion Elementary School, Pavilion	8:00	K

THURSDAY

4	Country Dancers	Ed Butenhof	New Life Community Church, 1000 Black Monroe Av.	8:00	J//LW7:15K
	Genesee Dancers	Callahan/Slomcenski	Green Lantern Inn, Fairport	7:45	PPK*
	Morton Country Swingers	Ron Fotch	Morton Baptist Church	7:30	ØK
	Wayne Westerners	Jeff Elmore	Primary School, Highland Av., Williamson	8:00	M+K
11	Country Dancers	Ceilden Beller	New Life Community Church, 1000 Black Monroe Av.	8:00	JL//W7:15K
	Genesee Dancers	Carmen/Slomcenski	Green Lantern Inn, Fairport	7:45	PPK*
	Morton Country Swingers	Ron Fotch	Morton Baptist Church	7:30	ØK
	Wayne Westerners	NO DANCE			
18	Country Dancers	Castner/Overacker	New Life Community Church, 1000 Black Monroe Av.	8:00	J//LW7:15K
	Genesee Dancers	Callahan/Slomcenski	Green Lantern Inn, Fairport	7:45	PPK*J
	Morton Country Swingers	Ron Fotch	Morton Baptist Church	7:30	ØK
	Wayne Westerners	Mike/MaryJaneHerne	Primary School, Highland Av., Williamson	8:00	FM+KR
25	Country Dancers	NO DANCE			
	Genesee Dancers	NO DANCE			
	Morton Country Dancers	NO DANCE			
	Wayne Westerners	NO DANCE			

FRIDAY

5	Promenading B's	?	Mystery Dance	6:30	%
	Boots 'N' Slippers	Callahan/Adams	Jonathan Underwood School, Hilton	8:30	KR8
	EKC-O Squares	Marsch/Wolcott	Kodak Park, 1669 Lake Ave.	8:00	RK
	Lima Grand Squares	Dick Casper	Lima Town Hall	8:30	KØ7:30
	Magic Squares	NO DANCE			
	Web Spinners	Bill Wilcox	Plank Rd. School, Plank Rd., Webster	8:15	**MKS
12	Boots 'N' Slippers	Callahan/Adams	Jonathan Underwood School, Hilton	8:30	KR8
	EKC-O Squares	Redmond/Wolcott	Kodak Park, 1669 Lake Ave.	8:00	RK
	Lima Grand Squares	NO DANCE			
	Magic Squares	Bob Ellis	Canandaigua Methodist Church, N. Main St.	8:30	Ø7:30M+K
	Pioneer Squares	Jon McNally	1st Presbyterian Church, East Av., Rochester	8:00	K
	Promenading B's	Myron Huss	Byron-Bergen Elem. School, W. Bergen Rd. off Rt.262	8:30	Ø7KF
	Web Spinners	Norm Wilcox	Plank Rd. School, Plank Rd., Webster	8:15	*MKF
	WYCO Promenaders	Travel			
19	Boots 'N' Slippers	Callahan/Adams	Jonathan Underwood School, Hilton	8:30	KR8
	EKC-O Squares	Redmond/Wolcott	Kodak Park, 1669 Lake Ave.	8:00	RK
	Lima Grand Squares	Dick Casper	Lima Town Hall (Harvest Dance)	8:30	KØ7:30
	Magic Squares	Bob Ellis	Canandaigua Methodist Church N. Main St.	8:30	Ø7:30M+K
	Country Twirlers	Bruce Shaw	Washington Irving School, 2400 Chili Avenue	8:00	KF
	Promenading B's	Ron Fotch	Byron-Bergen Elem. School, W. Bergen Rd. off Rt.262	8:30	JK
	Web Spinners	Bill Wilcox	Plank Rd. School, Plank Rd., Webster	8:15	*MK*
26	Lima Grand Squares	NO DANCE			
	Magic Squares	Bob Ellis	Canandaigua Methodist Church, N. Main St.	8:30	Ø7:30M+K
	Pioneer Squares	Jon McNally	1st Presbyterian Church, East Av., Rochester	8:00	K
	Promenading B's	NO DANCE			
	Web Spinners	NO DANCE			
	WYCO Promenaders	NO DANCE			



SATURDAY

6	Diamond Squares	Ellis/Reed	Covenant United Church, 1124 Culver Av.	8:00	RA1M+
	Hilton Hillbillies	Les Bradt	Parma Town Hall	7:00	JK
	Irondequoit Squares	McNally/Adams	Rochester Christian School, 260 Embury Rd., Penfld.	8:00	RK
	Orleans Orbits	Ron Fotch	YMCA, Pearl St., Medina	8:00	JK
	Swinging Squares	Les Bradt	Lutheran Church of Concord, Holmes Rd.	2-4p.m.	JK
13	Country Twirlers	Jack Barnes	Florence Brasser School, 1000 Coldwater Rd.	8:00	KR8
	Copy Cats	Callahan/Copeiland	Rochester Christian School, 260 Embury Rd., Penfld.	8:00	KPR
	Henrietta Friendship Sq.	Ron Fotch	Pinnacle Lutheran Church, 275 Pinnacle Rd.	8:00	KM
	Jerry's Gems	Jerry Carmen	S. Presbyterian Church, corner Rts. 15 & 15A	8:00	PPK
	Kuntry Kuzzins	Ellis/Mike Harris	Kelley School, Newark	8:00	K
	Swinging Squares	Les Bradt	Lutheran Church of Concord, Holmes Rd.	2-4p.m.	JK
	Swingin' Eights	Herne/Libertis	Ivan Green School, 800 Brown Rd., Irondequoit	8:00	GKJF
20	Country Dancer	Eric Rounds/band?	New Life Comm. Church, Rosedale/1000 BlackMonroeAv	8:00	L//Fsmety
	Hilton Hillbillies	Les Bradt	Parma Town Hall	7:00	JK
	Irondequoit Squares	Bob Ellis	Rochester Christian School, 260 Embury Rd., Penfld.	8:00	FRK
	Orleans Orbits	Ron Fotch	YMCA, Pearl Street, Medina	8:00	K
	Swinging Squares	Les Bradt	Lutheran Church of Concord, Holmes Rd.	2-4p.m.	K
	Swingin' Eights	Shaw/Libertis	Ivan Green School, 800 Brown Rd., Irondequoit	8:00	RK
27	Country Dancers	Eric/OverackerBand	New Life Comm. Church, Rosedale/1000 BlackMonroeAv.	8:00	//LExper.
	Country Twirlers	Jack Barnes	Washington Irving School, 2400 Chill Ave.	8:00	KR8
	Copy Cats	Casper/Herne	Rochester Christian School, 260 Embury Rd. Penfld.	8:00	KFR
	Henrietta Friendship Sq.	Ron Fotch	Pinnacle Lutheran Church, 275 Pinnacle Rd.	8:00	KM
	Irondequoit Squares	Jon McNally	Lutheran Church of Transfiguration/3760 Culver Rd.	8:00	PJ
	Kuntry Kuzzins	Shaw/Reed	Kelley School, Newark	8:00	K
	Swinging Squares	NO DANCE			

PROMENADER KEY symbols

A Advanced level
 B Benefit dance
 D St. Patrick's Dance
 E Elections
 F Guest caller
 G Graduation
 H Halloween Dance
 I Installation
 J See club news
 K Guests welcome
 L Live Music
 // Contra Club
 En English Dancing

M Mainstream
 PP Plus Program
 N National caller
 No Nominations
 O Open House
 P Potluck at 6:30
 P6 Potluck at 6:00
 P7 Potluck at 7:00
 R Rounds at 7:30
 R7 Rounds at 7:00
 APD All position dance
 AT Advanced level 1

I Traditional Square Dancing

R8 Rounds at 8:00
 ** Rounds at 7:15
 * Rounds at 7:45
 r Rounds at 8:30
 S Singing Calls
 T Trail End dance
 V Valentine dance
 W Workshop at 8:30
 W8 Workshop at 8:00
 W7 Workshop at 7:00
 ***Workshop at 7:30
 A2 Advanced level 2

X Christmas Dance
 Y New Years Dance
 Z Dinner Dance (restaurant)
 % Reservations required
 ? Fashion Show
 Ø Class Invited
 Ø7 Class at 7:00
 Ø8 Class at 8:00
 ! Amateur night
 @ Teen club
 # Workshop at 7:45
 = Closed, members only
 Ø Clogging

CALLERLAB

The International Association
 of Square Dance Callers

Box 679, Pocono Pines, Pa. 18350.
 717-646-8411

The National Executive Committee of the National Square Dance Convention and CALLERLAB are proud to announce that CALLERLAB will again be responsible for the annual Callers' Seminar to be held in conjunction with the National Square Dance Convention in Louisville, Kentucky on June 23, 24 and 25, 1983.

The National Executive Committee began sponsoring these seminars with the 1974 convention in San Antonio. Each year since that time, the panelists have all been members of CALLERLAB. In Milwaukee in 1979, the National Executive Committee turned over responsibility for the conduct of the seminar to CALLERLAB for the staffing and administrative details associated with the conduct of these seminars. This arrangement has proven satisfactory to all interested parties and the net result has been an on-going quality education program for all callers. These seminars are geared towards all callers regardless of skill level or affiliation with CALLERLAB.

These seminars are staffed with CALLERLAB accredited Caller-Coaches whenever possible. If additional callers are needed, callers actively engaged in caller training are used provided they are members of CALLERLAB. The topics to be covered during the scheduled twelve (12) hours of the seminar are taken from the CALLERLAB approved curriculum and are decided upon by the CALLERLAB Executive Committee based on the expertise of those staffing the sessions.

If you are a caller and plan to attend the National Square Dance Convention in Louisville, plan to attend as many of these panels as possible. Each session is independent from the others and all sessions are geared towards general calling skills. All choreographic sessions are limited to the use of Mainstream figures and terms since this has the widest applicability in the square dance picture. Each session is scheduled for two (2) hours and there are six (6) periods scheduled. It does not provide the same degree of education as a full callers' college but it does bring the expertise of several well qualified Caller-Coaches to various parts of the country at a convenient time.

The NEC and CALLERLAB feel that education forms a large part of their responsibilities to the activity and fully support these seminars as well as all educational topics presented at the various NSDCs.



FLADA'S 1ST

LEADERSHIP WORKSHOP

NOV. 14, 1982

\$6²⁵ Per Person

AT THE GRANDVIEW PLANTATION

4685 SENECA ST. WEST SENECA, NEW YORK

ALL MEMBERS OF RD./SQ. DANCE COMMUNITY INVITED

This workshop will be of interest to all Callers, Cuers, Officers, Club Board Members (old and new) and all dancers interested in the preservation and growth of our Square and Round Dance activity

- 2 - 5 P.M. • LEADERSHIP - An Overview
with Postive Ideas for Clubs
- CALLER - DANCER RELATIONSHIPS
Panel Discussion
 - GENERAL FORUM OF IDEAS,
QUESTIONS + DISCUSSION

5 - 6:30 COCKTAIL & DINNER HOUR

6:30 - 9 P.M. IMPROMTU SQUARES & ROUNDS

Reservations for dinner required by Nov. 1st.
Mail checks and make payable to Ethel Lee,
8660 Stahley Rd., East Amherst, New York 14051

PROMENADER

P. O. BOX 2

LE ROY, NEW YORK 14482

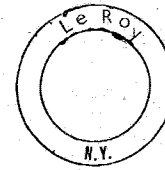

BULK RATE
U.S. Postage
PAID
LeRoy, NY
Permit No 62

Address Correction Requested



Nick & Arlene Capute
Box 2
LeRoy N.Y. 14482

We feature

invitations from

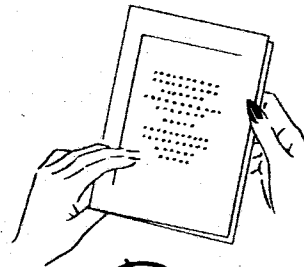

Chase

PERSONALIZED CHRISTMAS CARDS

MEMBER of BOOTS 'N SLIPPERS

JOHN J. FINK ENGRAVING COMPANY

Engravers and Printers of Fine Stationery

361 AMES STREET AT WESTERN EXPRESSWAY, ROCHESTER, NEW YORK 14611

(716) 436-4110